



# WICOMM

## Reference Manual



# Table of Contents

<b>1. INTRODUCTION .....</b>	<b>4</b>
EXPANDING YOUR SYSTEM.....	4
SELF-INSTALLATION .....	4
<b>2. SYSTEM COMPONENTS.....</b>	<b>5</b>
WHAT'S INCLUDED IN THE KIT .....	5
OPTIONAL DEVICES .....	6
SERIAL NUMBERS.....	8
<b>3. GUIDELINES FOR USING THE RISCO EXPRESS INSTALLATION WIZARD .....</b>	<b>10</b>
SELF-INSTALLATION .....	10
WELCOME SCREEN.....	10
PERSONAL INFO .....	10
SYSTEM INFO .....	10
SET-UP DEVICES .....	11
USER & CODES.....	11
INSTALL DEVICES.....	11
CONNECT TO NETWORK.....	11
DONE .....	13
<b>4. CONTROL PANEL INDICATIONS AND CONNECTIONS .....</b>	<b>14</b>
CONTROL PANEL FRONT VIEW.....	14
CONTROL PANEL REAR VIEW .....	15
<b>5. DEVICE MOUNTING CONSIDERATIONS .....</b>	<b>16</b>
MOUNTING CONSIDERATIONS FOR CONTROL PANEL.....	16
WIRELESS SIGNAL LOSS THROUGH CERTAIN BUILDING MATERIALS.....	17
PLACING THE MAIN UNIT.....	17
MOUNTING CONSIDERATIONS FOR MAGNETIC CONTACTS.....	18
MOUNTING CONSIDERATIONS FOR PIR DETECTORS.....	19
ACTIVATING THE BATTERY OF DOOR / WINDOW SENSOR .....	20
HOW TO MOUNT THE DOOR / WINDOW SENSOR .....	20



	BATTERY REPLACEMENT OF DOOR / WINDOW SENSOR .....	23
	ACTIVATING THE BATTERIES OF THE PIR DETECTOR .....	24
	HOW TO MOUNT THE PIR DETECTOR .....	24
	BATTERY REPLACEMENT OF PIR DETECTOR .....	28
<b>6.</b>	<b>WIRELESS DEVICE ALLOCATION .....</b>	<b>29</b>
	TABLE OF ADDITIONAL DEVICES .....	30
<b>7.</b>	<b>LOGGING INTO THE USER WEB &amp; APP .....</b>	<b>31</b>
	SETTING THE TIME ZONE .....	32
	CHANGING USER CODES .....	32
	CHANGE ZONE LABELS .....	34
	KEYCHAIN REMOTE BUTTONS .....	34
	<b>STANDARD LIMITED PRODUCT WARRANTY (“LIMITED WARRANTY”).....</b>	<b>35</b>



# 1. Introduction

This easy to install, “out-of-the-box”, system utilizes cutting-edge technologies to protect your home or small business against intrusion and safety hazards.

Easy to operate and robust, your security system is designed to provide you with peace of mind. Even during a power outage, it keeps fully working, monitoring, and providing alarm notifications.

System configuration and control is performed on-site or remotely using a wireless slim keypad or keychain remote, a mobile device (smartphone or Tablet PC) running the Android or iOS operating system, or a computer / laptop running a browser-based Web application. If using a motion detector with Smartphone and Web application users can also remotely view real-time images of the secured premises upon alarm activation, or at any given time. This “visual verification” feature can help you determine whether an alarm is false or real. In addition, 24/7 monitoring of your system can be available through security-monitoring services.

## Expanding your System

This kit contains all the necessary components required to operate your security system, however you can enhance and customize your system by adding additional detectors and accessories.

**Note:** It is recommended to add additional devices before starting the self-installation process.

## Self-Installation

For basic and simple installation it is necessary to use the RISCO Express Wizard that explains step-by-step on how to program and install the system (*see* 3. GUIDELINES FOR USING THE RISCO EXPRESS WIZARD).

From a computer or tablet with an internet connection and a web browser, follow the instructions from URL: <http://riscocloud.com/express>.

## 2. System Components

### What's Included in the Kit

Control Panel

Model RW232M

FCC-ID: JE4RW232M915

Contains FCC ID:QIPEHS6

Frequency:915Mhz ,916Mhz



Keychain remote

Model:WL 132KF1

FCC ID: JE4WL132KF1915

Frequency:915Mhz



Two Magnetic Door/Window Contacts  
(include sensor and magnet)

Models: RWX73F

FCC ID: JE4RWX73F915

Frequency:915Mhz



A "pet-friendly" PIR Motion Sensor

Models: RWX95P

FCC ID: JE4RWX73F915

Frequency:915Mhz



Electrical power adapter, Ethernet cable,  
screws and anchors



## Optional Devices

Wireless Slim Keypad including proximity  
reader for using proximity tags

Models: RW132KL1P, RW132KL2P

FCC ID: JE4RW132KLXP1356

Contains FCC ID: JE4STAMP915

Frequency:915Mhz,13.56Mhz



LCD Keypad including proximity reader for  
using proximity tags

Model: RW132KPPW3

FCC ID: JE4RW132KPP1356

Contains FCC ID: JE4STAMP915

Frequency:915Mhz,13.56Mhz



Wireless Smoke and Heat Detector

Model: RWX34

Contains FCC ID: JE4STAMP915

Frequency:915Mhz



Indoor Wireless Sounder

Model:WL S42

Contains FCC ID: JE4STAMP915

Frequency:915Mhz



Wireless acoustic Glassbreak Detector

Model: RWT6G

FCC ID: JE4RWT6G915

Frequency:915Mhz



Wireless Flood Detector and Sensor

Model: RWT6F

FCC ID: JE4RWT6F915

Frequency:915Mhz



---

**NOTE:** For device Technical Specifications, see RISCO's website at  
<https://www.riscogroup.com>.

---

## Serial Numbers

Serial numbers are used to identify the components of your security system as used in the RISCO Express Wizard. Each serial number consists of 11 digits.

Keep a record of components serial numbers and location by entering the relevant information in the table below that correspond to the devices serial numbers, as shown in these illustrations.



Magnetic door/window contact

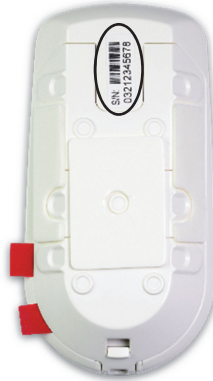

PIR Motion detector



Keychain Remote



<b>Component</b>	<b>Serial number (S/N)</b>	<b>Installation location / zone description</b>

## 3. Guidelines for using the RISCO Express Installation Wizard

### Self-Installation

It is necessary to use the RISCO Express Wizard to successfully and professionally install your WiComm Smart Hub System.

The RISCO Express Wizard walks you through the programming and installation of the system and connecting to the Cloud and Monitoring Station.

From a computer or tablet with an internet connection and a web browser, follow the stages of the RISCO Express Wizard instructions from URL:

<http://riscocloud.com/express>

### Welcome Screen

Enter the Kit Number **without the "W"** (see Serial Numbers) and 4-digit Verification Code as printed on the **Smart Hub**.

### Personal Info

Enter the following registration details (Name, Email and Password [the **Password must include at least one capital letter**]) into the provided fields. If you are already registered, enter your email and password on the right side of the window. Next, enter the 4-digit verification code sent to your inbox and used for creating your account.

---

If the email is not received, please check your junk mail.

---

### System Info

Enter a name for your system, for example, 10 Birchford Street.

The system can be divided into "Areas", for example, Garage, Home Office and House. Enter a name that is easily recognizable for each of the areas.

## Set-up Devices

This step enables the system to identify the sensors and accessories supplied in the basic kit. Additional sensors and accessories supplied and not shown in the list can be entered one at a time by entering the 11-digit Serial Number of each device.

## User & Codes

Assign new User Codes and a Master User Code.

---

**Note:** During system setup, it is recommended to change the Master User Code. The default Master User Code is 1234.

---

In addition, you can assign a Proximity Tag that is a personal electronic disc that when presented close to the Proximity-supported keypad functions the same as entering a personal user code.

It is recommended to add a user code for every user operating the system, as this user code will provide historical data of all functions performed by a specific user.

## Install Devices

Select the preferable network connection: Local Network (via router) or Mobile Connection (via SIM card). It is also possible to select both. Next, physically install the devices after considering the best location and then testing the devices detection strength.

---

**Note:** During installation of the devices, the communication LED  flashes

AMBER. Once installation is complete, the GREEN  LED flashes.

---

## Connect to Network

### Connecting a network cable to the WiComm

Your WiComm communicates via 3G cellular and/or internet. For 3G cellular you need to install a SIM card with data communication enabled (check with

your SIM card provider). For internet communication, connect the incoming network cable to the plug-in.

### **SIM Card Installation**

Insert the SIM into the dedicated SIM spring-loaded card slot located on the rear side of the control panel. The card clicks into place.

To enable 3G communication please ensure you move the locking switch to the right to **secure the SIM and enable it to operate**.

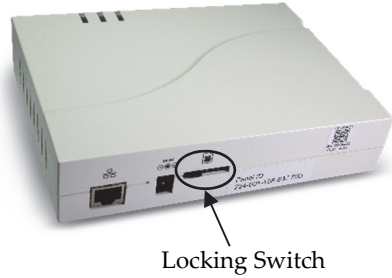

---

**Important:** Do not install the SIM card while power is applied to the WiComm. If power was applied before inserting the SIM card and the battery remains connected, hold down the reset button for 2 minutes and then release to reset the panel and enable the SIM card.

---

### **Connecting the WiComm to Power Supply**

1. Plug in the power adapter to your security system. Verify the following:

- The Power Led  is lit in **GREEN**.
- The Status light  is lit in **GREEN**.
- The communication LED  flashes **AMBER**.

2. After power up, the system will automatically establish communication with the cloud. Please wait a few minutes until the communication procedure has been completed before continuing with the installation wizard setup.

3. Continue with the remainder of the installation wizard and test the

system until all the devices are successfully installed, as indicated in the wizard.

When the installation wizard is complete, the communication LED will turn GREEN.



## **Done**

You have successfully completed the registration of your security system which is now ready for use. Refer to Chapter 7 for instructions on how to: log onto your Wicomm Smart Hub; change the time zone; and operate your system.

# 4. Control Panel Indications and Connections

## Control Panel Front View

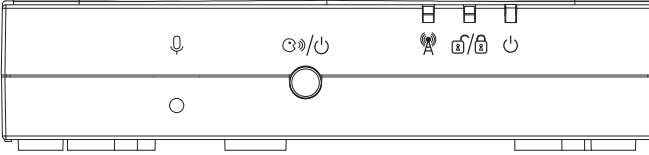

Microphone (for future use)

Status Button

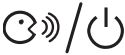

Press 1 second: The system will play local status messages

Press 3 seconds: Quick learn mode

Press 2 minutes: Resets the control panel

LED displays	Color	State	Status
 Power LED	Green	ON	Power OK
	Red	ON	AC trouble
	Orange	ON	Battery trouble.
 Status LED	Red	ON	System armed (Away or Stay)
		rapid flash	Alarm
		slow flash	System is in entry/exit delay before disarming/arming the system
	Green	ON	System ready

LED displays	Color	State	Status
		slow flash	System in Exit delay with front door open
	Orange	ON	System Trouble
	OFF		System not ready for arming
 Communication LED	Green	ON	GSM/IP connected
		slow flash	Cloud connected
	Orange	slow flash	GSM/IP Trouble
All LEDs	Orange	Slow flash	Battery Replacement mode (service mode)
	Green	Sequence flash	Wireless Learn mode

## Control Panel Rear View

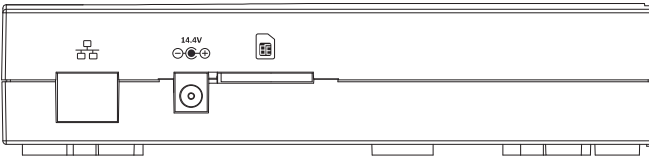

Ethernet connection

14.4V



Power Adaptor connector



SIM Card slot.

## 5. Device Mounting Considerations

### Mounting Considerations for Control Panel

For optimum installation of the control panel and detectors, make sure to follow the recommendations for the mounting location, as illustrated below.

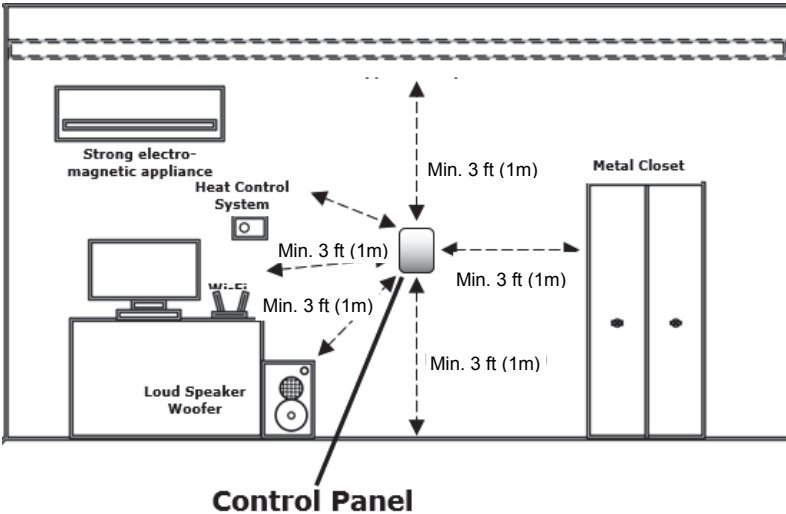

---

**NOTE:** The above illustrative diagram is intended to provide best results.

---



## Wireless Signal Loss through certain building materials

It is helpful to identify certain building materials that may be the cause of loss of signal strength and to make sure that the area around the control panel is free of such materials as much as possible. If signal interference is experienced, you may want to consider moving the control panel.

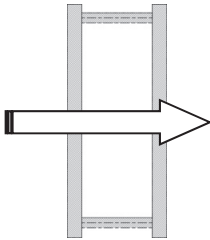
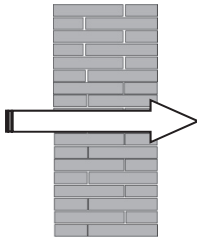
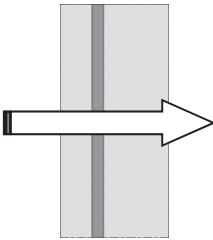
<p>0% - 10% loss of signal</p>  <p>Wallboard and Wood</p>	<p>5% - 35% loss of signal</p>  <p>Light Concrete or Brick</p>	<p>70% - 90% loss of signal</p>  <p>Heavy Concrete and Steel Reinforcement</p>
--	---	---

## Placing the main Unit

For upright independent placement:

Stand the control panel on a surface (e.g. table), adjust the swivel base of the control panel so that it is a stable upright positioning.

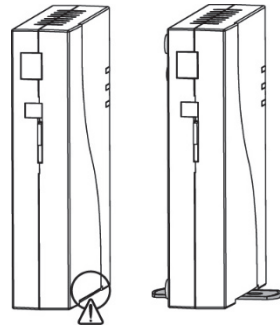

## Mounting considerations for Sensors

Wood & Metal Frame

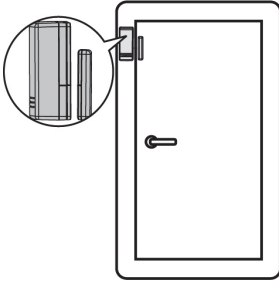

Wood Frame

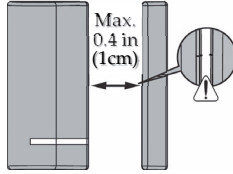

Metal Frame (possible 30% signal loss)

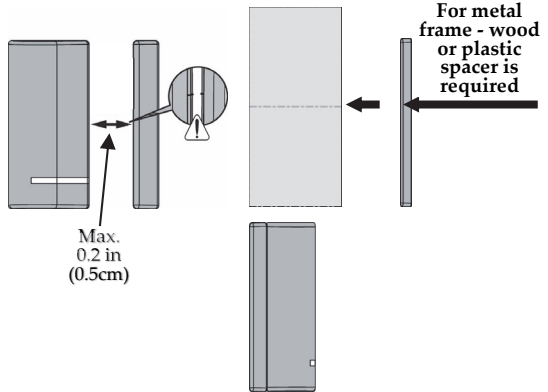

## Mounting considerations for PIR detectors

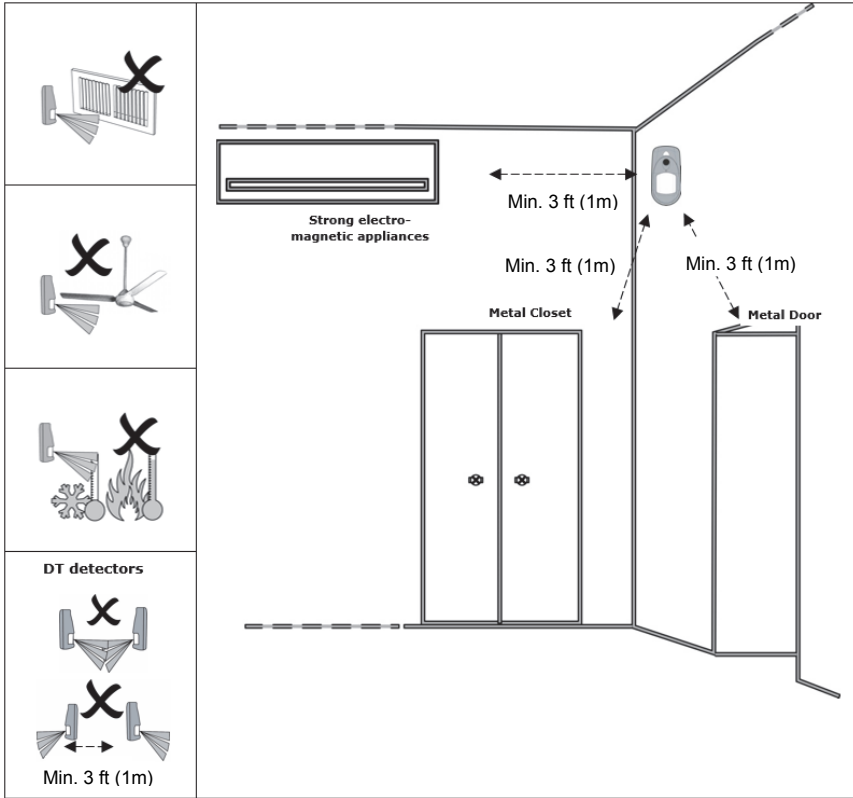

**NOTE:** Place the sensor just a foot (30 cm) or so lower than the ceiling. To provide maximum coverage, the sensor should be placed in a corner facing away from any windows and ideally towards the entrance of the room, or, follow the height specified in their Installation Instructions

## Activating the Battery of Door / Window Sensor

### Activating the battery

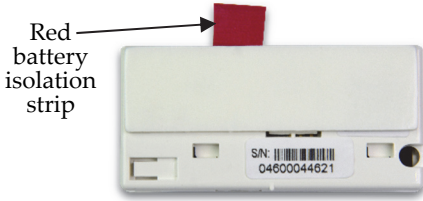

Remove the red battery isolation strip to activate the battery.

## How to Mount the Door / Window Sensor

### Mounting with Adhesive Tape

Peel the two-sided adhesive tapes from the sensor and magnet and attach the sensor and magnet to the mounting location.

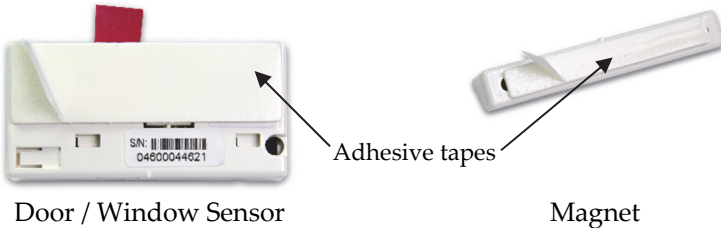

## Mounting with Screws

1. Insert a flathead screwdriver and rotate to detach the back of the transmitter from the back bracket (A). At the mounting location, note the alignment marks for both components (B), and then install accordingly using 2 mounting screws (C).
2. Detach magnet casing (D) and install with mounting screws (E).

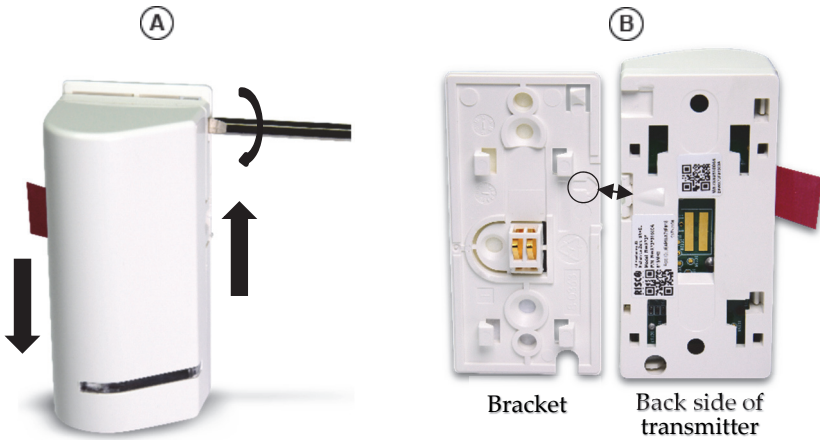

Ⓒ

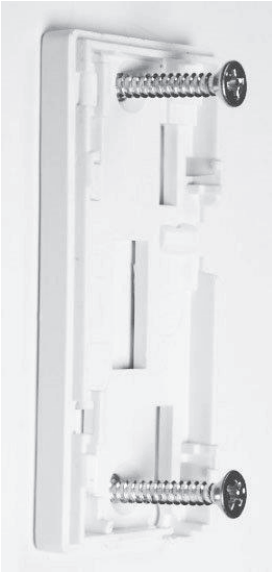

Ⓓ



Ⓔ

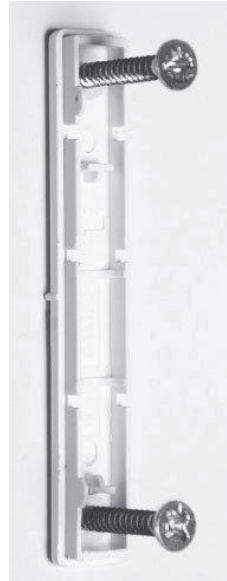

The mark on the magnet's case must be aligned with the mark on the transmitter's case.

## Battery Replacement of Door / Window Sensor

1. Release screw using a Phillips screwdriver (A) and then insert a flathead screwdriver into the slot and twist to open cover (B).

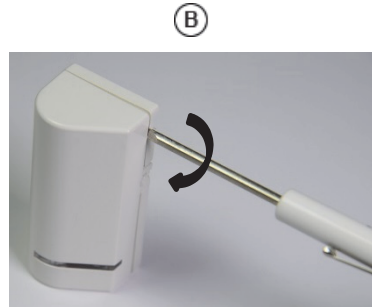

2. Insert the battery while observing + - polarity.



3. Put back cover firmly into place and secure with screw.



## Activating the Batteries of the PIR Detector

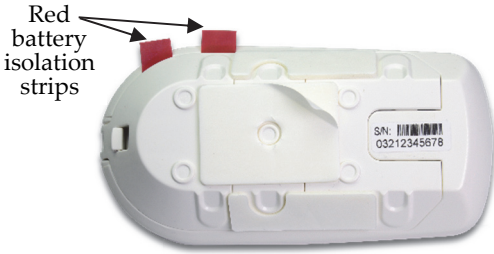

Remove the red battery isolation strips to activate the batteries.

## How to Mount the PIR Detector

### Mounting with Adhesive Tape

Peel the two-sided adhesive tapes from the detector and attach the detector to the mounting location.

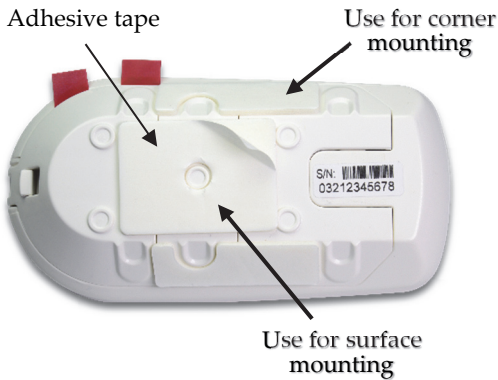



## Mounting with Screws



1. Release screw using a Phillips screwdriver.



2. Insert a flathead screwdriver into the slot and push to remove cover.

3. Open the knockout holes of the mounting bracket, and use them as a template for mounting.

### Corner Mounting

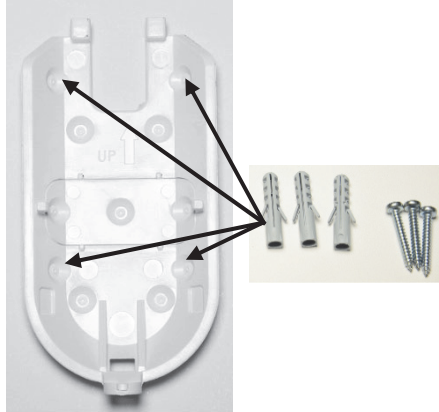

### Surface Mounting

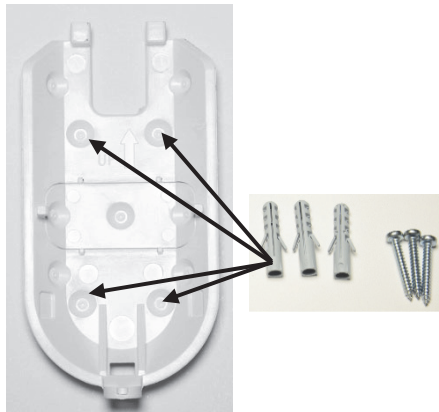



4. Slide the PIR detector downward onto the mounting bracket.



5. Insert and fasten the screw into the hole located at the bottom of the detector to lock the detector to the mounting bracket.

## Battery Replacement of PIR Detector



1. Press in the tab and lift to open the battery compartment cover.



2. Insert the batteries while observing + - polarity.



3. Slide back cover into place and secure with screw.

## 6. Wireless Device Allocation





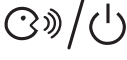
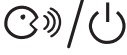

The initial installation of the system must be performed using the RISCO Express Wizard. If additional accessories are purchased at a later stage, they must be allocated (“enrolled”) to the system using the method described below, and not using the RISCO Express Wizard.

You can quickly allocate all system devices (including keypads) at the control panel. In case of future enrollment of additional devices, refer to the device Installation Instructions.

To enter the Smart Hub into Quick learn mode press the  button for 3 seconds – all LEDs will sequentially flash. When the Smart Hub is in the Quick learn mode, perform the transmission procedure listed in the table below. When complete, press the  button once to exit this mode.

The Smart Hub will announce when the device is allocated. The zone name may be edited using the user website at <https://www.riscocloud.com>.

## Table of Additional Devices

Wireless Device	Transmission procedure
<b>PIR Detectors:</b> <ul style="list-style-type: none"> <li>• Motion Detector-PIR camera</li> <li>• Motion Detector Pet camera</li> </ul>	Press the tamper switch for 3 seconds.
<b>Door/Window Detector</b>	Press the tamper switch for 3 seconds.
<b>Keychain remote</b>	Press  and  simultaneously for at least 2 seconds
<b>LCD Keypad</b>	Press  and  simultaneously for at least 2 seconds
<b>Slim Keypad</b>	Press  and  simultaneously for at least 2 seconds.
<b>Smoke/Heat Detector</b>	After inserting battery, transmission is sent automatically within 10 seconds.
<b>Internal Sounder</b>	Press the reset switch on the siren. After a squawk sounds, you have 10 seconds to press on the tamper switch for at least 3 seconds.
<b>Glassbreak Detector</b>	Press the tamper switch for 3 seconds.

## 7. Logging into the User Web & App

Log into the iRISCO website at <https://www.riscocloud.com>.

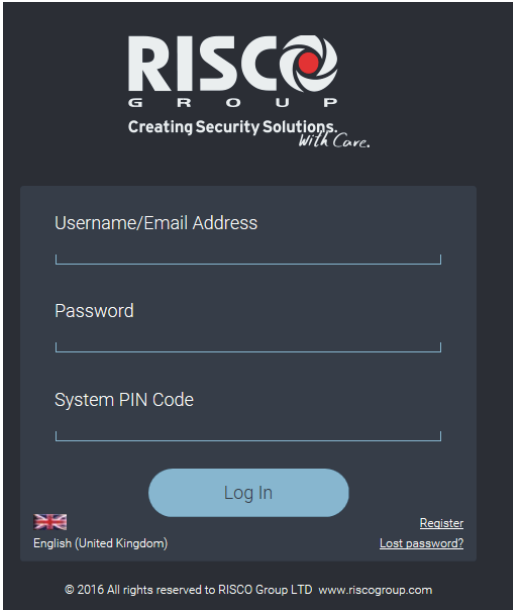

The screenshot shows the RISCO Group login interface. At the top is the RISCO GROUP logo with the tagline "Creating Security Solutions. With Care." Below the logo are three input fields: "Username/Email Address", "Password", and "System PIN Code". A blue "Log In" button is positioned below the input fields. At the bottom left, there is a language selection menu showing a UK flag and "English (United Kingdom)". At the bottom right, there are links for "Register" and "Lost password?". The footer contains the copyright notice: "© 2016 All rights reserved to RISCO Group LTD www.riscogroup.com".

1. Enter your email address and password selected at the start of registration.
2. For the required "PIN Code" enter your assigned 4-digit Master User code selected during the "User & Codes" stage of the RISCO Express Wizard.

## Setting the Time Zone

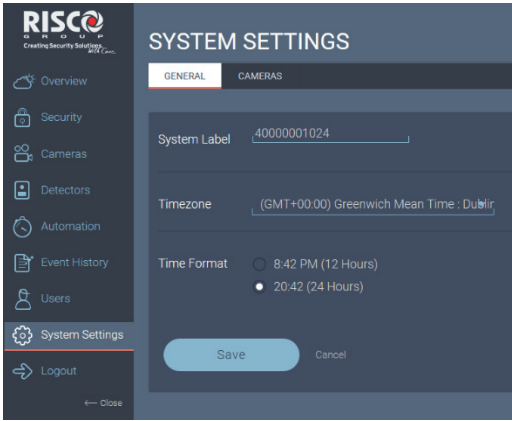

1. Click the **System Settings** link in the left-hand column of the screen.
2. Click the **Date and Time** button; the SYSTEM SETTINGS page displays the current time zone and time format.
3. Make the required changes.
4. Click **Save**.

---

**NOTE:** The date and time, Time Zone descriptions and users cannot be set by the smartphone application and must be set through the website using the Master User / PIN code only.

---

## Changing User Codes

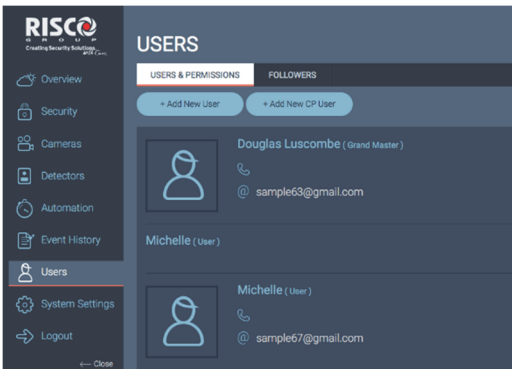

1. Click the **Users** link in the left-hand column of the screen.
2. To edit a user, select an existing user to edit.
3. To add a new user, select "+Add New User". The new user can control the system via the Web/APP and on a



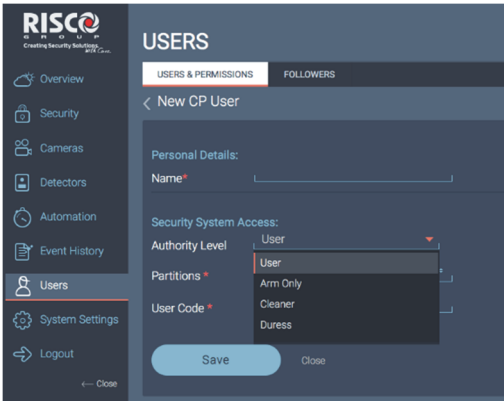
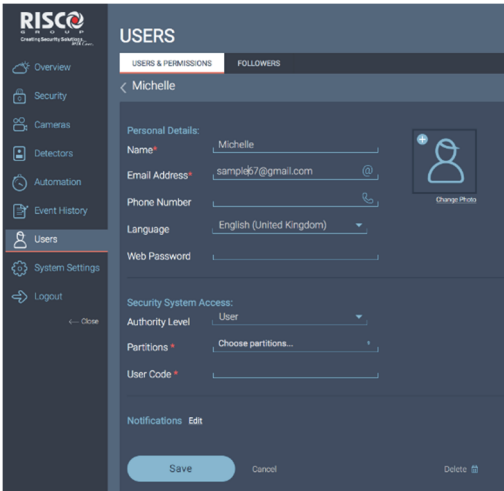

keypad, if installed.

4. Select “+Add New CP User” to add a user that can control the system only via a keypad, if installed.
5. Click the arrow to the right of “Authority Level” and select one of the following:

- **User** – used to arm/disarm the system.
- **Arm Only** – used only to arm the system.
- **Cleaner** – used only for one-time arming and disarming.
- **Duress** – used to disarm the system when forced to, in which case it will send out a Duress notification.

## Change Zone Labels

1. Click the **Detectors** link in the left-hand column of the screen.

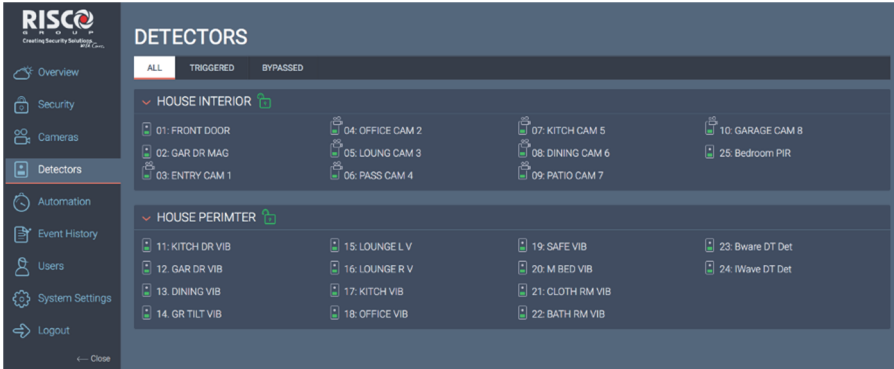

2. Select the detector you wish to edit.
3. Select the pencil icon next to the zone label.
4. Edit the zone label.
5. Click **Close**.

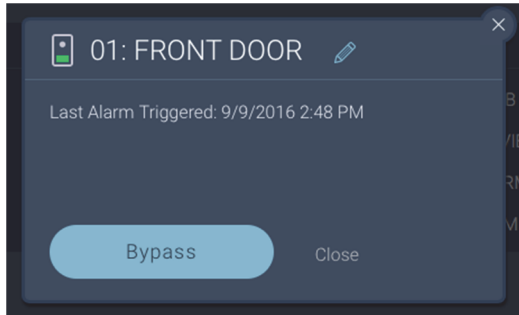

## Keychain Remote Buttons

Button	Operation	Button	Operation
	Full arm		Disarm
	Partial arm		Announces status of panel



# Standard Limited Product Warranty ("Limited Warranty")

RISCO Ltd. ("RISCO") guarantee RISCO's hardware products ("Products") to be free from defects in materials and workmanship when used and stored under normal conditions and in accordance with the instructions for use supplied by RISCO, for a period of (i) 24 months from the date of delivery of the Product ( the "Warranty Period"). This Limited Warranty covers the Product only within the country where the Product was originally purchased and only covers Products purchased as new.

**Contact with customers only.** This Limited Warranty is solely for the benefit of customers who purchased the Products directly from RISCO or from an authorized distributor of RISCO. RISCO does not warrant the Product to consumers and nothing in this Warranty obligates RISCO to accept Product returns directly from end users who purchased the Products for their own use from RISCO's customer or from any installer of RISCO, or otherwise provide warranty or other services to any such end user directly. RISCO's authorized distributor or installer shall handle all interactions with its end users in connection with this Limited Warranty. RISCO's authorized distributor or installer shall make no warranties, representations, guarantees or statements to its end users or other third parties that suggest that RISCO has any warranty or service obligation to, or any contractual privity with, any recipient of a Product.

**Remedies.** In the event that a material defect in a Product is discovered and reported to RISCO during the Warranty Period, RISCO shall accept return of the defective Product in accordance with the below RMA procedure and, at its option, either (i) repair or have repaired the defective Product, or (ii) provide a replacement product to the customer.

**Return Material Authorization.** In the event that you need to return your Product for repair or replacement, RISCO will provide you with a Return Merchandise Authorization Number (RMA#) as well as return instructions. Do not return your Product without prior approval from RISCO. Any Product returned without a valid, unique RMA# will be refused and returned to the sender at the sender's expense. The returned Product must be accompanied with a detailed description of the defect discovered ("**Defect Description**") and must otherwise follow RISCO's then-current RMA procedure published in RISCO's website at [www.riscogroup.com](http://www.riscogroup.com) in connection with any such return. If RISCO determines in its reasonable discretion that any Product returned by customer conforms to the applicable warranty ("**Non-Defective Product**"), RISCO will notify the customer of such determination and will return the applicable Product to customer at customer's expense. In addition, RISCO may propose and assess customer a charge for testing and examination of Non-Defective Product.



**Entire Liability.** The repair or replacement of Products in accordance with this Limited Warranty shall be RISCO's entire liability and customer's sole and exclusive remedy in case a material defect in a Product is discovered and reported as required herein. RISCO's obligation and this Limited Warranty are contingent upon the full payment by customer for such Product and upon a proven weekly testing and examination of the Product functionality.

**Limitations.** This Limited Warranty is the only warranty made by RISCO with respect to the Products. The warranty is not transferable to any third party. To the maximum extent permitted by applicable law, this Limited Warranty shall not apply and will be void if: (i) the conditions set forth above are not met (including, but not limited to, full payment by customer for the Product and a proven weekly testing and examination of the Product functionality); (ii) if the Products or any part or component thereof: (a) have been subjected to improper operation or installation; (b) have been subject to neglect, abuse, willful damage, abnormal working conditions, failure to follow RISCO's instructions (whether oral or in writing); (c) have been misused, altered, modified or repaired without RISCO's written approval or combined with, or installed on products, or equipment of the customer or of any third party; (d) have been damaged by any factor beyond RISCO's reasonable control such as, but not limited to, power failure, electric power surges, or unsuitable third party components and the interaction of software therewith or (e) any failure or delay in the performance of the Product attributable to any means of communication provided by any third party service provider, including, but not limited to, GSM interruptions, lack of or internet outage and/or telephony failure. BATTERIES ARE EXPLICITLY EXCLUDED FROM THE WARRANTY AND RISCO SHALL NOT BE HELD RESPONSIBLE OR LIABLE IN RELATION THERETO, AND THE ONLY WARRANTY APPLICABLE THERETO, IF ANY, IS THE BATTERY MANUFACTURER'S WARRANTY. RISCO does not install or integrate the Product in the end user's security system and is therefore not responsible for and cannot guarantee the performance of the end user's security system which uses the Product or which the Product is a component of.



This Limited Warranty applies only to Products manufactured by or for RISCO. Further, this Limited Warranty does not apply to any software (including operating system) added to or provided with the Products or any third-party software, even if packaged or sold with the RISCO Product. Manufacturers, suppliers, or third parties other than RISCO may provide their own warranties, but RISCO, to the extent permitted by law and except as otherwise specifically set forth herein, provides its Products "AS IS". Software and applications distributed or made available by RISCO in conjunction with the Product (with or without the RISCO brand), including, but not limited to system software, as well as P2P services or any other service made available by RISCO in relation to the Product, are not covered under this Limited Warranty. Refer to the Terms of Service at: <https://riscocloud.com/ELAS/WebUI/UserLogin/License> for details of your rights and obligations with respect to the use of such applications, software or any service. RISCO does not represent that the Product may not be compromised or circumvented; that the Product will prevent any personal injury or property loss by burglary, robbery, fire or otherwise, or that the Product will in all cases provide adequate warning or protection. A properly installed and maintained alarm may only reduce the risk of a burglary, robbery or fire without warning, but it is not insurance or a guarantee that such will not occur or will not cause or lead to personal injury or property loss. CONSEQUENTLY, RISCO SHALL HAVE NO LIABILITY FOR ANY PERSONAL INJURY, PROPERTY DAMAGE OR OTHER LOSS BASED ON ANY CLAIM AT ALL INCLUDING A CLAIM THAT THE PRODUCT FAILED TO GIVE WARNING.

EXCEPT FOR THE WARRANTIES SET FORTH HEREIN, RISCO AND ITS LICENSORS HEREBY DISCLAIM ALL EXPRESS, IMPLIED OR STATUTORY, REPRESENTATIONS, WARRANTIES, GUARANTEES, AND CONDITIONS WITH REGARD TO THE PRODUCTS, INCLUDING BUT NOT LIMITED TO ANY REPRESENTATIONS, WARRANTIES, GUARANTEES, AND CONDITIONS OF MERCHANTABILITY, FITNESS FOR A PARTICULAR PURPOSE, TITLE AND WARRANTIES AGAINST HIDDEN OR LATENT DEFECTS, TO THE EXTENT PERMITTED BY LAW. WITHOUT LIMITING THE GENERALITY OF THE FOREGOING, RISCO AND ITS LICENSORS DO NOT REPRESENT OR WARRANT THAT: (i) THE OPERATION OR USE OF THE PRODUCT WILL BE TIMELY, SECURE, UNINTERRUPTED OR ERROR-FREE; (ii) THAT ANY FILES, CONTENT OR INFORMATION OF ANY KIND THAT MAY BE ACCESSED THROUGH THE PRODUCT SHALL REMAIN SECURED OR NON DAMAGED. CUSTOMER ACKNOWLEDGES THAT NEITHER RISCO NOR ITS LICENSORS CONTROL THE TRANSFER OF DATA OVER COMMUNICATIONS FACILITIES, INCLUDING THE INTERNET, GSM OR OTHER MEANS OF COMMUNICATIONS AND THAT RISCO'S PRODUCTS, MAY BE SUBJECT TO LIMITATIONS, DELAYS, AND OTHER PROBLEMS INHERENT IN THE USE OF SUCH MEANS OF COMMUNICATIONS. RISCO IS NOT RESPONSIBLE FOR ANY DELAYS, DELIVERY FAILURES, OR OTHER DAMAGE RESULTING FROM SUCH PROBLEMS. RISCO WARRANTS THAT ITS PRODUCTS DO NOT, TO THE BEST OF ITS KNOWLEDGE,



INFRINGE UPON ANY PATENT, COPYRIGHT, TRADEMARK, TRADE SECRET OR OTHER INTELLECTUAL PROPERTY RIGHT IN ANY EVENT RISCO SHALL NOT BE LIABLE FOR ANY AMOUNTS REPRESENTING LOST REVENUES OR PROFITS, PUNITIVE DAMAGES, OR FOR ANY OTHER INDIRECT, SPECIAL, INCIDENTAL, OR CONSEQUENTIAL DAMAGES, EVEN IF THEY WERE FORESEEABLE OR RISCO HAS BEEN INFORMED OF THEIR POTENTIAL

.

This RISCO product was purchased from:



This device complies with part 15 of the FCC Rules. Operation is subject to the following two conditions:

- (1) This device may not cause harmful interference, and
- (2) This device must accept any interference received, including interference that may cause undesired operation.

Changes or modifications to this equipment which are not expressly approved by the party responsible for compliance (RISCO Group's.) could void the user's authority to operate the equipment.

### **FCC Note**

This equipment has been tested and found to comply with the limits for a Class B digital device, pursuant to part 15 of the FCC Rules.

These limits are designed to provide reasonable protection against harmful interference in a residential installation. This equipment generates uses and can radiate radio frequency energy and, if not installed and used in accordance with the instructions, may cause harmful interference to radio communications. However, there is no guarantee that interference will not occur in a particular installation. If this equipment does cause harmful interference to radio or television reception, which can be determined by turning the equipment on and off, the user is encouraged to try to correct the interference by one or more of the following measures:

- ✦ Reorient or relocate the receiving antenna.
- ✦ Increase the separation between the equipment and the receiver.
- ✦ Connect the equipment into an outlet on to a different circuit from that to which the receiver is connected.
- ✦ Consult the dealer or an experienced radio/TV technician for help.
- ✦ The distance between user and device should be no less than 20cm.

No part of this document may be reproduced in any form without prior written permission from the publisher.